

USER'S MANUAL

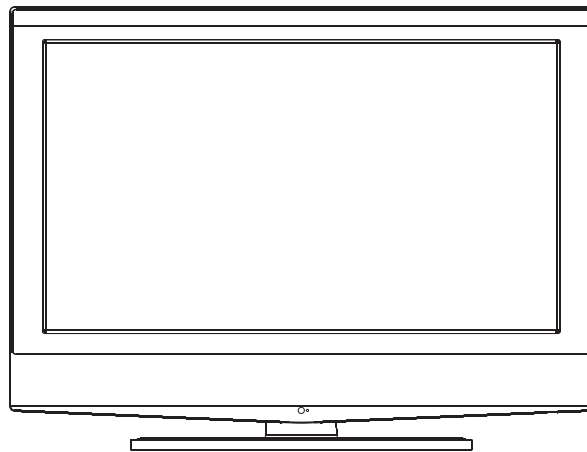

Model: LCDVD194



Please read this User Manual carefully to ensure the proper use of this product and keep this manual for future reference

Contents

1、 Safety and warnings.....	2-6
2、 Introduction.....	7
3、 Installation.....	8-13
4、 Remote control.....	14
5、 Operation.....	15-16
6、 Trouble Shooting.....	17
7、 Wall Mounting Holes Spacing and Location.....	18
8、 Base Stand Disassemble Illustration.....	18
9、 DVD part.....	19-34
11、 DVD Trouble Shooting.....	35

IMPORTANT SAFETY INSTRUCTIONS



IMPORTANT SAFETY INSTRUCTION

1. Read these safety instructions.
2. Keep these safety instructions.
3. Heed all warnings.
4. Follow all safety instructions.
5. Do not use this apparatus near water.
6. Clean only with dry cloth.
7. Do not block any ventilation openings. Install in accordance with the manufacturers instructions.
8. Do not install near any heat sources such as radiators, heat registers, stoves, or other apparatus (including amplifiers) that produce heat.



9. Do not defeat the safety purpose of the polarized or grounding type plug. A polarized plug has two blades with one wider than the other. A grounding type plug has two blades and a third grounding prong. The wide blade or the third prong are provided for your safety. If electrician for replacement of the obsolete outlet.
10. Protect the power cord from being walked on or pinched particularly at plugs convenience receptacles, and the point where they exit from the apparatus.
11. Only use attachments/accessories specified by the manufacturer.
12. Unplug this apparatus during lightning storms or when unused for long periods of time.
13. Refer all servicing to qualified service personnel. Servicing is required when the apparatus has been damaged in any way, such as power-supply cord or plug is damaged, liquid has been spilled or objects have fallen into apparatus, the apparatus has been exposed to rain or moisture, does not operate Normally, or has been dropped.
14. Apparatus shall not be exposed to dripping or splashing and no objects filled with liquids, such as vases, shall be placed on the apparatus. important safety instruction.
15. Splashing The apparatus shall not be exposed to dripping or splashing and no objects filled with liquids, splashing and no objects filled with liquids such as vases, shall be placed on the apparatus.
16. A warning that an apparatus with class I construction shall be connected to a MAINS Socket outlet with a protective ear thing connection.

IMPORTANT SAFETY INSTRUCTION

	CAUTION RISK OF ELECTRIC SHOCK DO NOT OPEN!	
CAUTION TO REDUCE THE RISK OF ELECTRIC SHOCK, DO NOT REMOVE COVER (OR BACK). NO USER SERVICEABLE PARTS INSIDE. REFER SERVICING TO QUALIFIED SERVICE PERSONNEL.		



The symbol indicates that dangerous voltage constituting a risk of electric shock is present within this unit.



The symbol indicates that there are important operating and maintenance instructions in the literature accompanying this unit.

WARNING: TO PREVENT FIRE OR SHOCK HAZARD, DO NOT EXPOSE THIS APPLIANCE TO RAIN OR MOISTURE.



Caution

The DVD video player is a class 1 laser product. Use of controls or adjustments or performance of procedures other than those specified herein may result in hazardous radiation Exposure. As the laser beam used in this DVD video player is harmful to the eyes, do not attempt to disassemble the Cabinet. Refer servicing to qualified personnel only.

WARNINGS AND CAUTIONS

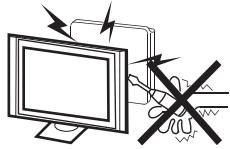

Warning

High voltages are used in the operation of this television receiver. Do not remove the cabinet back from your set. Refer servicing to qualified service personnel.

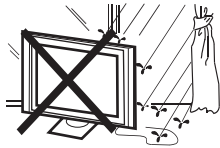

Warning

To prevent fire or electrical shock hazard, do not expose the television receiver to rain or moisture.



Warning

Do not drop or push objects into the television cabinet slots or openings. Never spill any kind of liquid on the television receiver.



Caution

Do not block the ventilation holes in the back cover. Adequate ventilation is essential to prevent failure of electrical components.



Caution

Do not squash power supply cord under the television receiver.

WARNINGS AND CAUTIONS

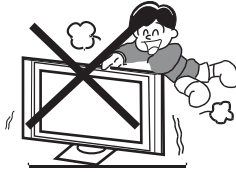

Caution

Never stand on, lean on, or suddenly push the television or its stand. You should pay special attention to children. Serious injury may result if it falls.

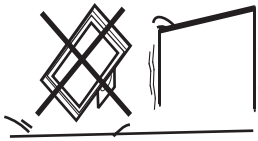

Caution

Do not place your television on an unstable cart, stand, shelf or table. Serious injury to an individual, and damage to the television, may result if it falls.

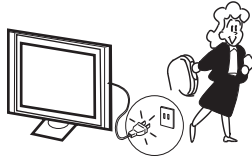

Caution

When the television receiver is not used for an extended period of time, it is advisable to disconnect the AC power cord from the AC outlet.

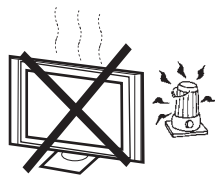

Caution

Avoid exposing the television receiver to direct sunlight and other sources of the heat. Do not stand the television receiver directly on other products which give off heat. E.g. video cassette players and audio amplifiers. Do not place naked flame sources, such as lighted candles on the television.

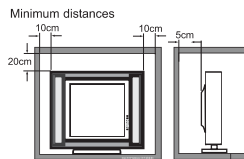

Caution

If the television is to be built into a compartment or similar enclosed, the minimum distances must be maintained. Heat build-up can reduce the service life of your television, and can also be dangerous.

WARNINGS AND CAUTIONS

Thank you very much for purchasing this TV. To enjoy your product from the very beginning, read this manual carefully and keep it handy for ready reference.

INSTALLATION

- Locate the TV in the room where light does not strike the screen directly.
- Total darkness or a reflection on the picture screen can cause eyestrain. Soft and indirect lighting is recommended for comfortable viewing.
- Allow enough space between the TV and the wall to permit ventilation.
- Avoid extremely warm locations to prevent possible damage to the cabinet or premature component failure.
- This TV can be connected to AC 100-240 Volts. 50/60 Hz. Never connect to a DC supply or any other power supply.
- Do not cover the ventilation openings when using the TV.

CAUTION

Never tamper with any components inside the TV, or any other adjustment controls not mentioned in this manual. All LCD-TVs are high voltage instruments. When you clean up dust or water drops on the LCD PANEL or CABINET, the power cord should be pulled out from the receptacle, then wipe the TV with dried soft cloth. During thunder and lightning, unplug the power cord and antenna cord to prevent damage to your TV. All repairs to this TV should only be performed by the TV service personnel.

Warning: Change or modifications to this unit not expressly by the part responsible for compliance could void the use's authority to operate the Equipment.

Main features

- ① Used as Television, display terminal, PC display;
- ② High luminance, wide viewing angle;
- ③ Can store 125 TV programs;
- ④ Translucency OSD, Auto-search;
- ⑤ Full function Remote Control;

Main parameter

PANEL SIZE	48cm (19inch) diagonal
BRIGHTNESS	300cd/m ²
CONTRAST	800:1
TV SYSTEM	NTSC-M, NTSC-N
INPUT	Antenna 75 Ohm Coaxial Cable
	HDMI 1
	VGA 1
	YPbPr 1
	AV 1
	AUDIO 2
Speaker	4 Ohm x 2
Audio Output	3W x 2
Power Consumption	AC100-240, 50/60Hz, 50 W
Dimension	464(W) x 140(D) x 392(H) mm
Net Weight	4.7 kg
Transmitting System	Infrared
Power Supply	DC 3V (1.5 x 2)
Dimension	212(W) x 45(L) x 20(D) mm
Net Weight	80g

Accessories

- Infrared Remote Control..... 1
- User's Manual..... 1
- Battery(AAA).....2

Front panel

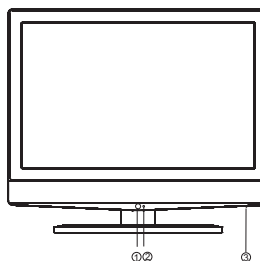

1. Remote control sensor
2. Indicator LED
3. Power: Press this button to turn the unit ON from STANDBY mode. Press it again to turn the set back to STANDBY.

Side panel

- 1 SOURCE**
Display the input source menu.
- 2 MENU**
To display TV MENU.
- 3 CH+/CH-**
In TV mode press CH+ or CH- to change the channel up and down.
In MENU,press CH+ or CH- to select items in MENU.
when TV is in standby mode, press CH+ or CH- button in TV control panel will power on the TV.
- 4 VOL+/VOL-**
Adjust sound level.
In MENU,adjust the item that you Selected.

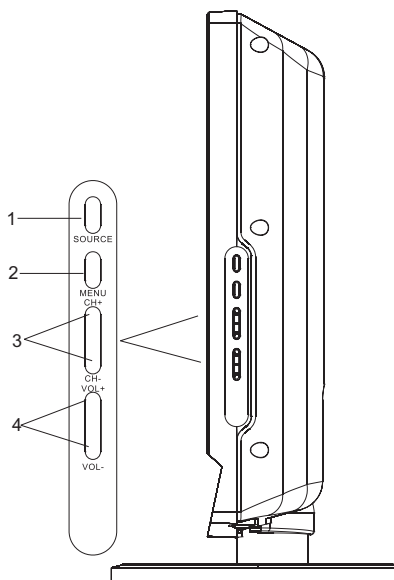

REAR AV Connection



All the terminals are(from left to right):

AC INPUT,HDMI ,VGA ,AV,YPbPr,AUDIO INPUT,PC AUDIO INPUT ,ANTENNA

Note: VIDEO and YPbPr share one audio channel.

ANTENNA

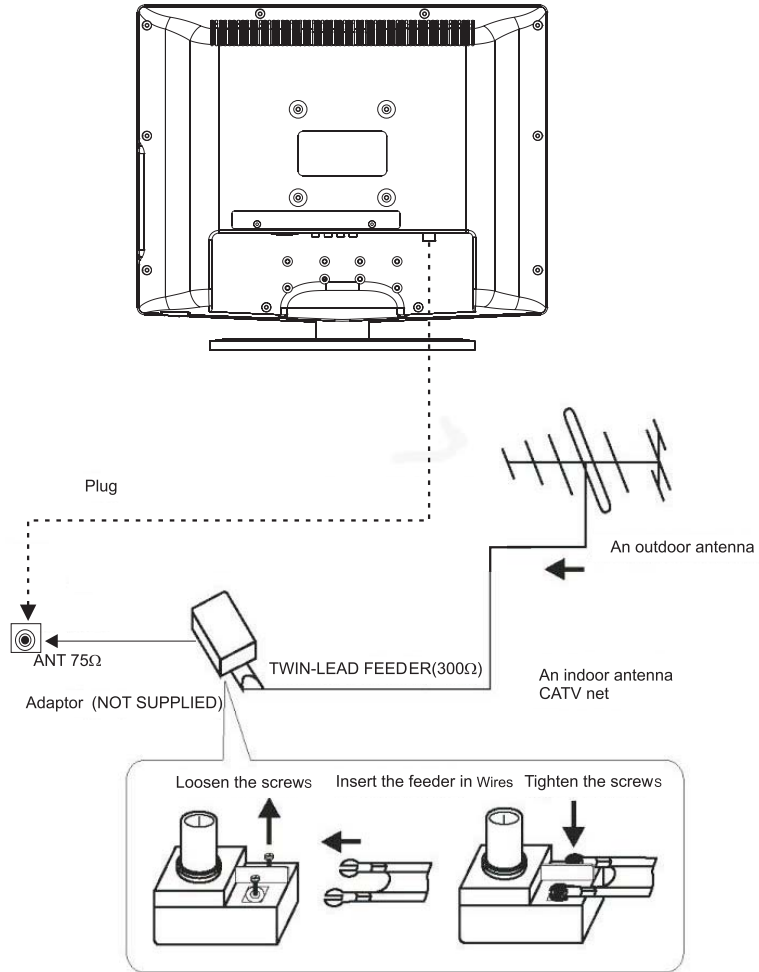

Note:
Aerial connections: IEC (female).
Input impedance: 75Ω unbalanced.

PC

STEPS:

Be sure both the TV and computer are Power off.

1. Connect VGA and audio cable
2. Connect power cord
3. Power on the TV, switch to PC mode
4. Power on the PC

This sequence is very important.

** Please don't open the Cover*

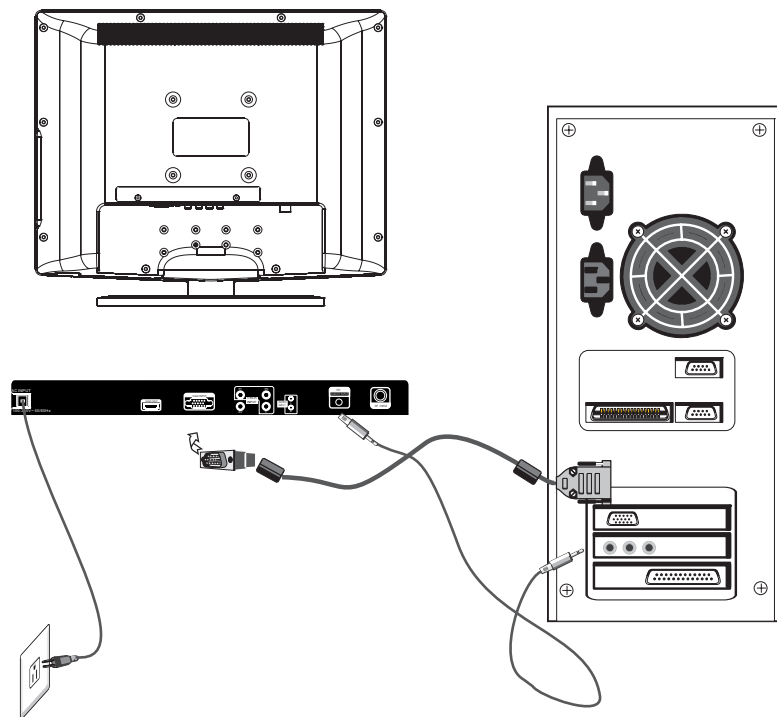

PC

PRESET MODE(recommended resolution is 1024*768@60Hz)

	RESOLUTION	V.Freq.(Hz)	H.Freq.(KHz)
1	640*480	60	31.47
2	800*600	56	35.156
3	800*600	60	37.88
4	1024*768	60	48.36

AV EQUIPMENT

This TV provides one group of AV ,COMPONENT for convenient connection to VCR,DVD or other video equipment. Please refer to the owners manual of the equipment to be connected as well.

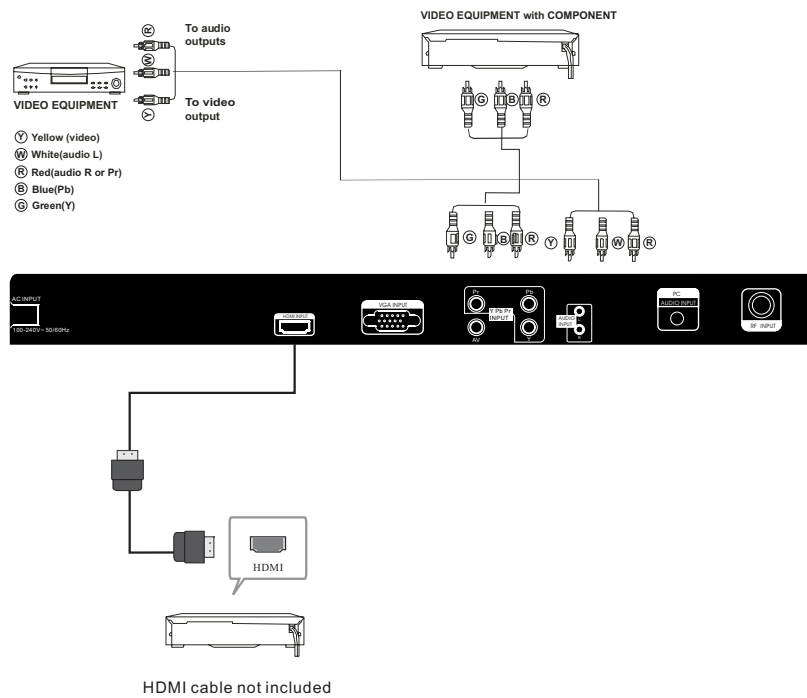

It can be connected to the following appliances: VCR, multi disc player, DVD, camcorder, video game or stereo system, etc.....
YPbPr can support these video fomats:480i,576i,480p,576p,720p,1080i.

BATTERY INSTALLATION

Insert Batteries Into the Remote Control

1. Remove the battery cover.
2. Insert the 2 AAA 1.5V batteries making sure the polarity (+ or -) of the batteries matches the polarity marks inside the unit.
3. Mount the battery cover.

Replace with new batteries when the TV set begins to show the following symptoms:
Operation is unsteady or erratic. Sometimes the TV set does not function with Remote Control Unit.

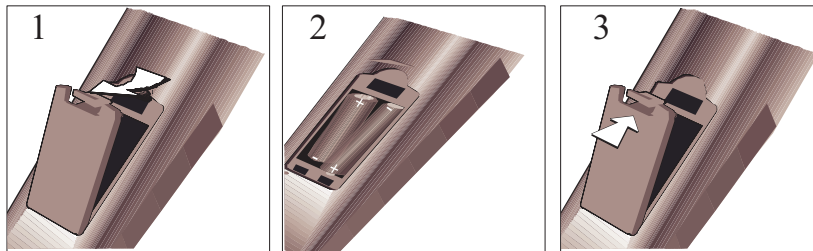

Remark:

- 1) Alkaline Battery Recommended.
- 2) Remove batteries when they are exhausted or if the remote control is not to be used for a long time.

REMOTE CONTROL

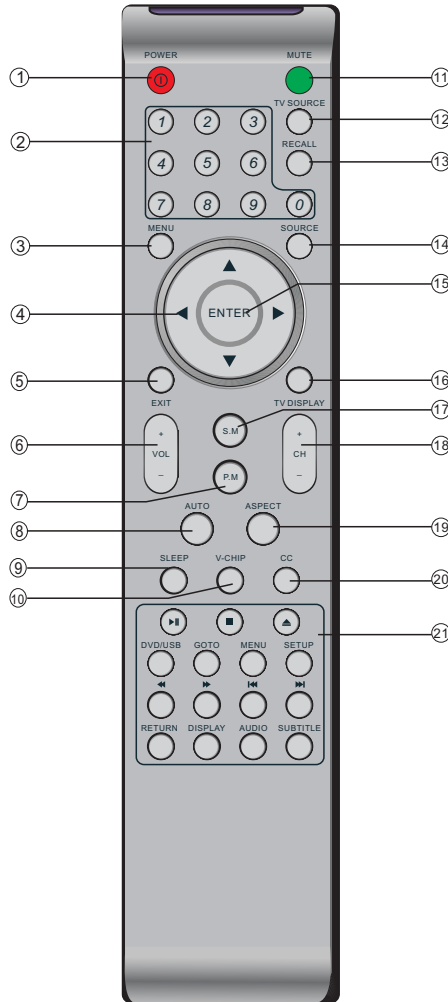

- 1: **POWER**
To set the TV standby or on.
- 2: **NUMBER KEY:**
For direct access to program. For a 2 (3) digit program number, The second (third) digit must be entered before the dash disappears. Channel number will be displayed for a few seconds.
- 3: **MENU**
To display TV menu.
- 4: **CURSOR**
To move within the menu.
- 5: **EXIT**
Used to return to the previous menu or exit menu.
- 6: **VOL +/-**
To adjust sound level.
- 7: **P.M**
To switch picture mode.
- 8: **AUTO**
Auto adjust in PC mode.
- 9: **SLEEP**
Set time to turn off the TV.
- 10: **V-CHIP**
Enter parent ctrl
- 11: **MUTE**
To disable or enable the sound.
- 12: **TV SOURCE**
To change TV SOURCE [CABLE, AIR]
- 13: **RECALL**
To access the previously viewed program.
- 14: **SOURCE**
To display or exit TV input source Menu.
- 15: **ENTER**
Confirms selection.
- 16: **TV DISPLAY**
Displays/removes the program Information
- 17: **S.M**
To switch sound mode.
- 18: **CH+/CH-**
To access the next or previous Program.
- 19: **ASPECT**
To change picture aspect .
- 20: **CC**
Display caption during closed caption Source.
- 21: Only use for with built-in DVD Player(option)

1. PICTURE MENU

The first item of the MENU is picture menu. You can adjust picture here, such as contrast, brightness, etc. press ◀▶ to move, press ⏴⏵ To Adjust.

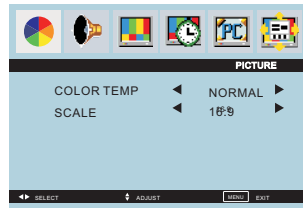
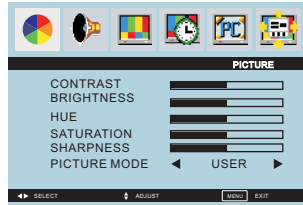

Note:

1. Three color temperatures: NORMAL, WARM, COOL.
2. Four picture modes: STANDARD, MOVIE, VIVID, USER.
3. HUE is available in NTSC system only.

2. SOUND MENU

The second item of the MENU is SOUND MENU. You can adjust sound here. Press ◀▶ to move, press ⏴⏵ to adjust.

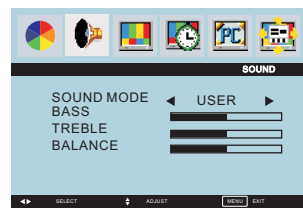

3. CHANNEL MENU

The third item of the MENU is channel menu (Only in TV mode). You can complete channel Search and setting here.

1. AUTO SCAN: Search all the channels automatically.
2. ADD/ERASE: To skip the current channel yes or not.
3. SOURCE: CABLE, AIR.
4. C. CAPTION: adjust c.c. Type.
5. PARENTAL CTRL: enter parent ctrl menu, The default password is 6666.

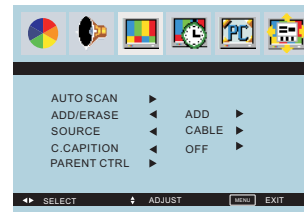

4. FUNCTION MENU

The fourth item of the MENU is function menu. You can adjust settings below.

1. SLEEP TIMER: adjust sleep time
2. DNR: noise reduction
3. MEMORY RECALL: Reset all the Settings to default value.

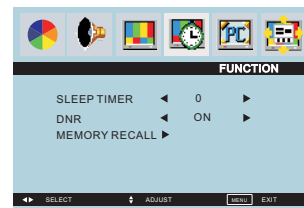

PARENTAL CTRL

You can adjust setting below .

- 1.PASSWORD:you can change the current PARENTAL CTRL password.
- 2.PARENTAL CTRL, you can turn off or On it .
- 3.TV-RATING, you can enter TV rating Menu to adjust.

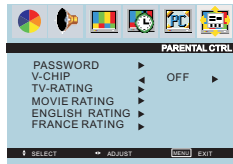

6.PC MENU

This MENU is available in PC only. You can adjust the PC effect and position.

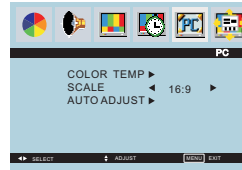
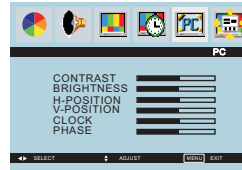

















Auto adjust in PC mode only.

5.OSD MENU

The sixth item of the MENU is OSD Menu.

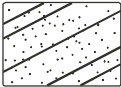

Trouble shooting

Trouble phenomenon		Inspection
Picture	Audio	
 <p>Snow</p>	 <p>Noise</p>	antenna position, direction or connection.
 <p>Ghost</p>	 <p>Normal audio</p>	antenna position, direction or connection.
 <p>Interfere</p>	 <p>Noise</p>	electronic equipment, car/motorcycle, fluorescent light.
 <p>Normal Picture</p>	 <p>Mute</p>	Volume(check whether the mute function is on or sound system are correct or not).
 <p>No picture</p>	 <p>Mute</p>	power cord is not connected. power switch is not opened. Press standby key on the remote control to trying.
 <p>No color</p>	 <p>Normal audio</p>	Color control.
 <p>Scramble</p>	 <p>Normal audio or weak</p>	Search the channel again.
 <p>No color</p>	 <p>Noise</p>	Audio system.

Wall Mounting Holes Spacing and Location

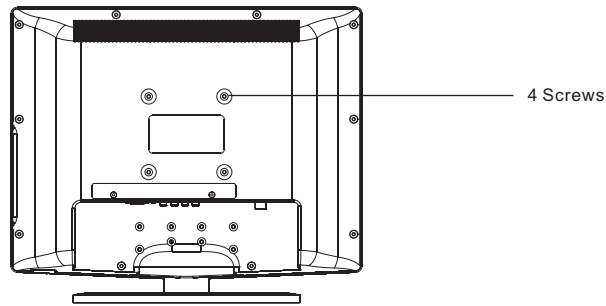

Base Stand Disassemble Illustration

How to remove the stand from the TV

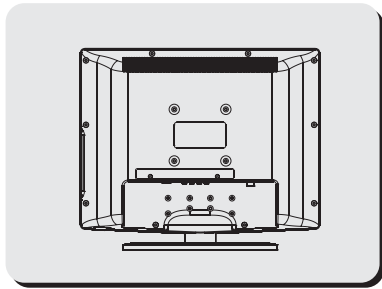

1. Use the screwdriver to remove the screws from the screw location.

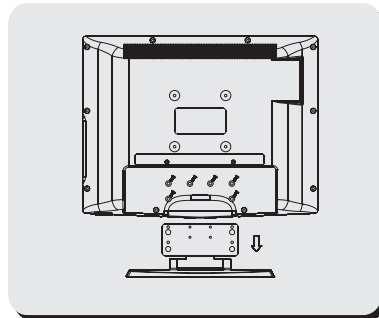

1. Remove the base stand from the Main body.



Caution

The DVD video player is a class 1 laser product. Use of controls or adjustments or performance of procedures other than those specified herein may result in hazardous radiation Exposure. As the laser beam used in this DVD video player is harmful to the eyes, do not attempt to disassemble the Cabinet. Refer servicing to qualified personnel only.

DVD SIDE PANEL

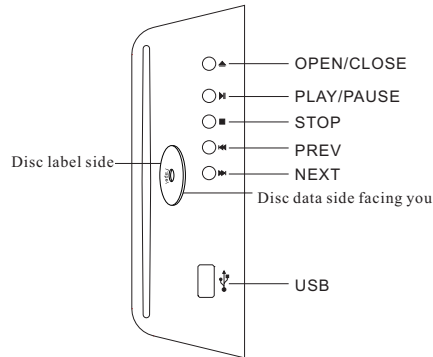

How to enter DVD source

Please press the SOURCE key and select the DVD item, then LCDTV will enter DVD mode.

USB

In DVD mode, press DVD/USB button in the remote controller, you can insert a USB disc or a Mp3 player with USB interface to play the mp3, JPEG and Mp4 files.

Caution:

When using USB function, please do not insert in the wrong direction, or else it will be damaged.

When insert the disc, pls put the data side of the disc in the front, and put the label side of the disc in the back of you.

Features

Disc formats supported by this player:



Dolby Digital



Subtitle choices



DVD video



Audio choices



Parental Lock

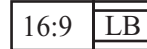

TV Aspect Ratio modes

This product incorporates copyright protection technology that is protected by method claims of certain U.S. patents and other intellectual property rights owned by Macro vision Corporation and other rights owners. Use of this copyright protection technology must be authorized by Macro vision Corporation, and is intended for home and other limited viewing uses only unless otherwise authorized by Macro vision Corporation. Reverse engineering or disassembly is prohibited.

Manufactured under license from Dolby Laboratories. "Dolby" and the double-D symbol are trademarks of Dolby Laboratories. Confidential Unpublished Works. ©1992-1997 Dolby Laboratories, Inc. All rights reserved.

1. General Steps of setup menu

A) Press the DVD SETUP button, the main setup menu appears.

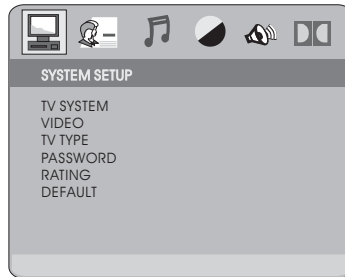

B) Press the Left and Right arrow buttons to highlight the icon of the desired page, then press the Down or Up arrow button to activate that page. For example, if you want to setup the video page, press Right to highlight the video icon, the video page will be displayed on the screen.

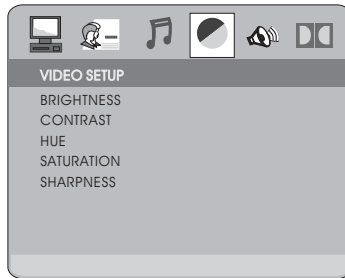

C) Press the Down arrow button to highlight the desired option. Press Enter or press Right arrow to select. The choices of that option appear on the right. For example, press the Down row button to highlight the BRIGHTNESS option, then press Enter To select, the brightness choices appear on the right.



A) Press the Arrow buttons to highlight the Exit Setup option, then press Enter or Setup again to exit Setup Menu.

2. Setup Items Introduction

2.1 SYSTEM SETUP

The system setup options are illustrated below:

2.1.1 TV SYSTEM

According to the Color System of the TV, you can choose the TV System.

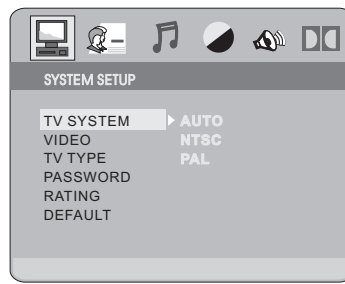

2.1.2 VIDEO

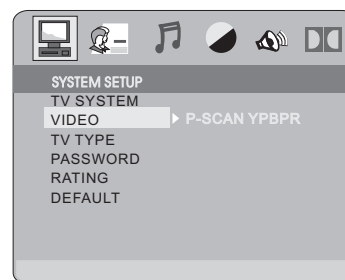

2.1.3 TV TYPE

According to the TV type, you can choose 16:9,4:3LB or 4:3PS.

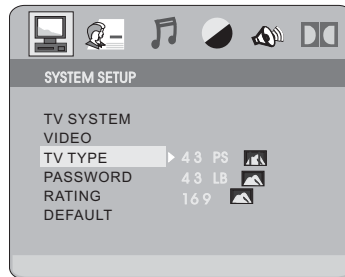

2.1.4 PASSWORD

The password option is initially locked, and you can not set the ratings limit or change the password. In order for the Ratings feature to work, the password mode must be turned on. If you want to set the ratings limit, you will need to enter the default password. Which is 6666. then press Enter to confirm. To change the password, you will be prompted for the old password, then be prompted for new one. Enter a 4-digit number (this is your password). Press remember your PASSWORD, as the DEFAULT setting will revert everything. But the PASSWORD to the factory defaults.

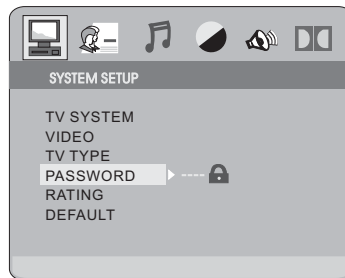

2.1.5 RATING

The Rating feature is a rating limit system, like movie ratings. It works with DVD discs that have been assigned a rating. This helps you control the types for DVDs that your family watches.

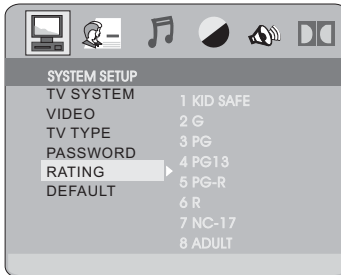

2.1.6 DEFAULT

The DEFAULT setup options are RESTORE factory setup. Let your player work on best state.

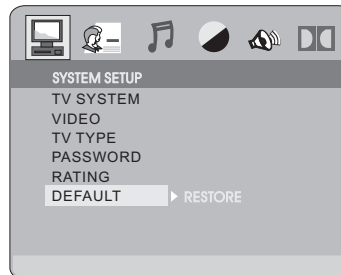

2.2 LANGUAGE SETUP

The language setup options are illustrated below:

2.2.1 OSD LANGUAGE

Highlight the OSD LANGUAGE option, and press the Arrow buttons to choose the OSD language you prefer. Press Enter to confirm, and it will display OSD in that language.

Note: The OSD LANGUAGE display is subject to sales country.

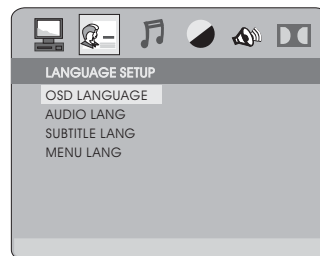

2.2.2 AUDIO LANG

Highlight the AUDIO LANG option, and press the Arrow buttons to choose the audio language you prefer. Press Enter to confirm. If the disc you are playing has that language available, it will output that language

Note: The AUDIO LANGUAGE display is subject to sales country.

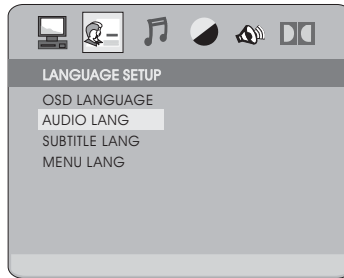

2.2.3 SUBTITLE LANG

Highlight the SUBTITLE LANG option, and press the Arrow buttons to choose the subtitle language you prefer. Press Enter to confirm. If the disc you are playing has that language available, it will display subtitles in that language.

Note: The SUBTITLE LANGUAGE display is subject to sales country..

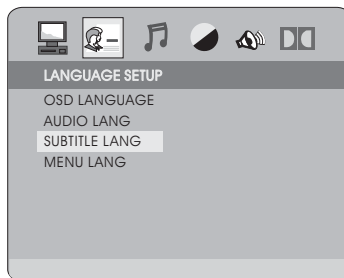

2.2.4 MENU LANG

Highlight the MENU LANG option, and press the Arrow buttons to choose the menu language you prefer. Press Enter to confirm. If the disc you are playing has that Language available. It will display the menu in the language.
Note: The MENU LANGUAGE display is subject to sales country..



2.3 AUDIO SETUP



2.4 VIDEO SETUP

The video setup options are illustrated below:

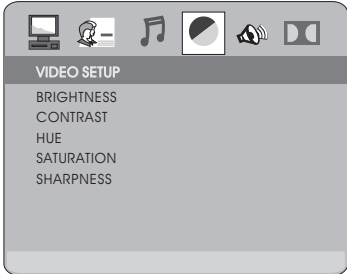

2.4.1 BRIGHTNESS

Use the Up and Down arrow buttons to move the scroll and adjust the brightness.

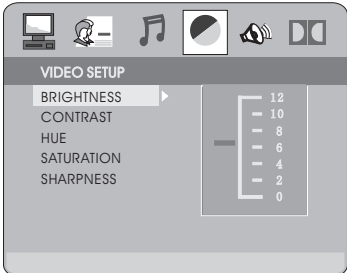

2.4.2 CONTRAST

Use the Up and Down arrow buttons to move the scroll and adjust the contrast.

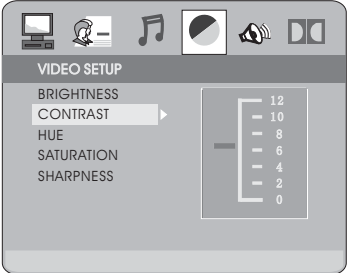

2.4.3 HUE

Use the Up and Down arrow buttons to move the scroll and adjust the hue.

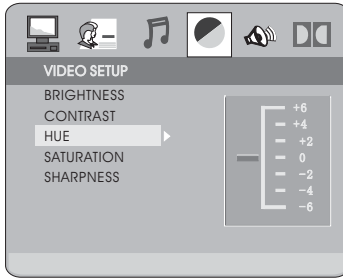

2.4.4 SATURATION

Use the Up and Down arrow buttons to move the scroll and adjust the saturation.

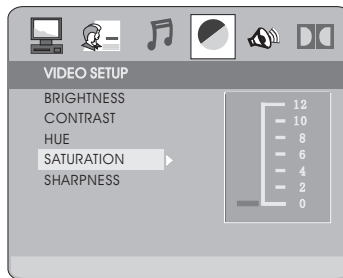

2.4.5 SHARPNESS

Use the Up and Down arrow buttons to move the scroll and adjust the Sharpness.

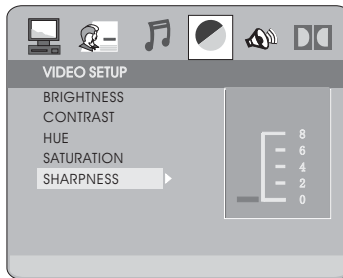

2.5 SPEAKER SETUP

The speaker setup options are illustrated below:

2.5.1 DOWNMIX

- A) LT/RT Choose this setting when the DVD player is connected to a 2 Channel Analog Audio input.
- B) STEREO Choose this setting when the DVD player is connected to a TV or therefore modulator.



2.6 DIGITAL SETUP

The DIGITAL SETUP options are illustrated below:

2.6.1 DYNAMIC RANGE

When LINE OUT is selected, choose this setting to adjust the line out ratio for different effects.

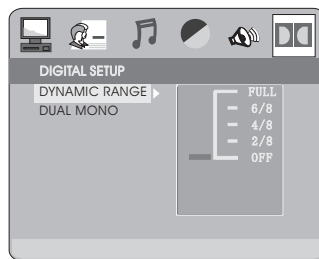

2.6.2 DUAL MONO (LEFT + RIGHT)

Choose to setup the L and R mono output mode. There are four modes in this option: STEREO, MONO L, MONO R, and MIX MONO.

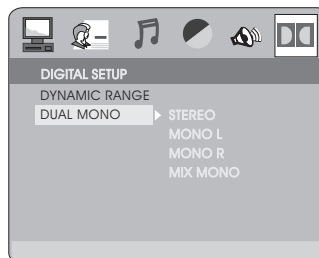

DVD REMOTE CONTROL OPERATION

0-9 keys ● These keys are used to input the time, as well as title, chapter and track numbers.



● When a numeric item is displayed on the screen, press the 0-9 keys to select the desired entry, and press ENTER to confirm.

● When a numeric item is larger than 9 press the GOTO key to select the display entry.

UP/DOWN/LEFT/RIGHT



● Used to navigate menus.

MENU



● During DVD/VCD, playback, press MENU to return to the program menu.

Note: This function is subject to the disc.

SETUP



● Press SETUP button to enter or exit the setup menu.

PLAY/ PAUSE



● Press PLAY/PAUSE from stop mode to start play.

● Press PLAY/PAUSE during playback to pause playback.

● Press PLAY/PAUSE to resume normal playback.

STOP



● Press STOP once during playback to stop and hold playback.

● Press PLAY to resume playback from the point you pressed STOP.

● Press STOP twice to stop playback completely.

DVD REMOTE CONTROL OPERATION

DVD/USB



- Switch between disc and USB operation.

REV



- During DVD or CD playback, press and hold ◀◀ to scan in reverse. The player will review the disc at 2, 4, 8 and 20 times normal speed as follows:

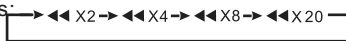

Press PLAY to resume normal playback.

FWD



- During DVD or CD playback, press and hold ▶▶ to scan forward. The player will review the disc at 2, 4, 8 and 20 times normal speed as follows:

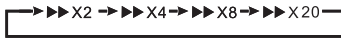

Press PLAY to resume normal playback.

RETURN



- During DVD playback, press RETURN to display the DVD title menu or play the first title.

Note: this function is subject to the disc.

DVD REMOTE CONTROL OPERATION

DISPLAY



During playback, press DISPLAY to show the current time counter position.

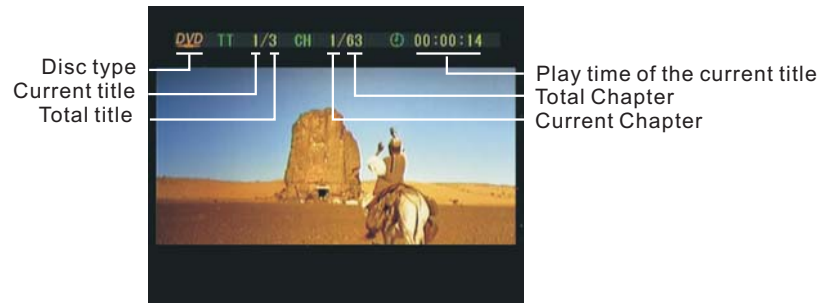

Press DISPLAY to show the Audio and Subtitle message menu.



OPEN/ CLOSE



● To open the disc tray, press OPEN/CLOSE.

● To close the disc tray, press OPEN/CLOSE again.

DVD REMOTE CONTROL OPERATION

GOTO



During playback, press GOTO show the current time counter position.

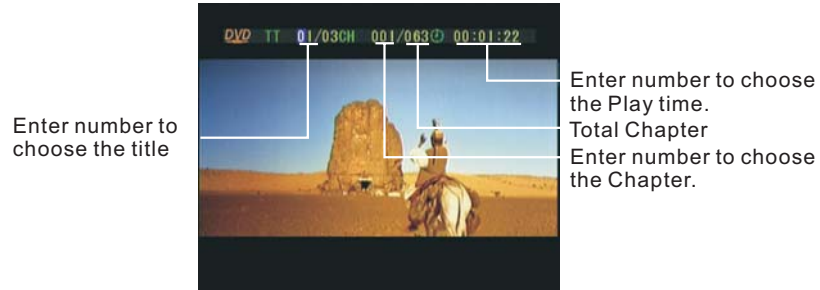

NEXT



● Press NEXT to skip to the next chapter or track.

PREV



● Press PREV to skip to previous chapter or track.

SUBTITLE



During DVD playback

● Press SUBTITLE repeatedly to select from up to 32 subtitle languages.

Note: This function is disc specific.

AUDIO



During DVD playback

● Press AUDIO repeatedly to select from up to 8 Audio language/formats.

Note: This function is disc specific.

ENTER



● Pressing <ENTER> will enter the selected item in a menu.

MP3 PLAYBACK

When a MPEG and a MP3 disc is loaded, the screen will be displayed as follows:

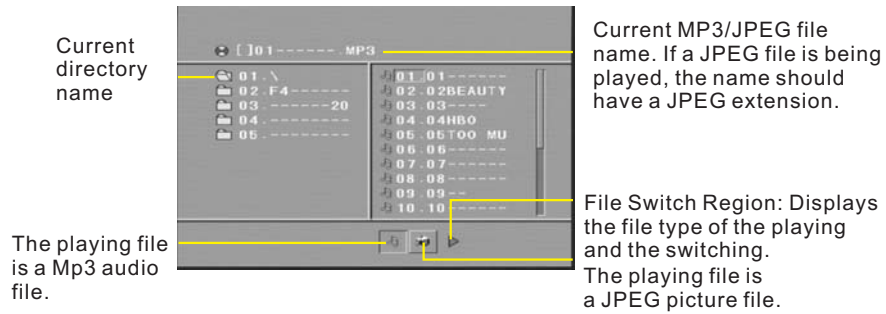

- Press \square to select the file when the cursor appears in the file window.
- Press \triangleright to play the current file selected by the cursor.
- Press \square to switch between the directory window and the file window.

Note:

During MP3 playback, Forward Scan and Reverse Scan are not available.

Note:

The player will not identify or play a MP3 disc under the following conditions: the recording format is not supported(make sure the files are in MP3 format),the disc is badly scratched, damaged or dirty, the disc is not finalised.

DVD Trouble shooting

If you have any questions, please consult the troubleshooting guide below:

NO PICTURE OR SOUND

- Ensure the power button is on.
- Ensure the power outlet is operational.
- Ensure the power cord is not damaged.
- Ensure the power plug is connected firmly to the outlet.

PICTURE BUT NO SOUND

- Ensure the audio is not set to mute.
- Ensure you have set the player's AUDIO settings correctly.

POOR PICTURE OR SOUND

- Ensure you have set the player's AUDIO settings correctly
- Ensure the disc is not scratched or stained.

"BAD DISC" DISPLAYED

- Ensure the disc is not warped, damaged or deformed.
- Ensure the disc is not badly stained or damaged.
- Ensure the disc format is compatible with the player.
- Please check whether you have tried to play a software CD. If so, please restart the player.

REMOTE NOT WORKING

- Make sure the Main unit's POWER button is on
- Ensure the remote batteries are working.
- Point the remote control directly at the player's IR sensor.
- Remove any obstacles between the remote and the IR sensor.

UNIT NOT WORKING

- Turn off the power, and then turn it on again.

"NO DISC" DISPLAYED

- Ensure you have put the disc on the tray.
- Ensure the disc is not upside down.
- Ensure the disc is not distorted, stained or scratched.



This symbol on the product or in the instructions means that your electrical and electronic equipment should be disposed at the end of life separately from your household waste. There are separate collection systems for recycling in the EU. For more information, please contact the local authority or your retailer where you purchased the product.